



Ultrasonic Scaler Instruction Manual

PT6/PT6 PRO

Please read this manual before operating

Guilin Refine Medical Instrument Co., LTD.

RF-PT6-M003 Version: 1.0 20230531

Contents

| | |
|---|----|
|  Safety Precautions | 1 |
| Symbol instruction | 3 |
| 1 Product introduction | 3 |
| 2. Installation | 7 |
| 3 Function and Operation | 10 |
| 4 Trouble shooting | 11 |
| 5 Cleaning, disinfecting and sterilizing | 12 |
| 6 Transportation, storage and maintenance | 13 |
| 7 Environmental protection | 13 |
| 8 After service | 13 |
| 9 EMC - Declaration of conformity | 14 |
| Attachment. Reprocessing instructions of cleaning, disinfecting and sterilizing | 19 |

Safety Precautions

⚠ WARNING: If you neglect these safety precautions, you may cause personal injury such as electric shock, fire or damage to the product.

















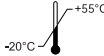

The use of the product must comply with the requirements of the relevant operating specifications and relevant laws and regulations of the medical department. The user must be a professionally trained and qualified dentist or technician. Adequate protection (such as safety goggles, face shield, etc.) should be equipped during operation to prevent cross-infection.

1. Please do not use other than the specified voltage. Before connecting the built-in ultrasonic scaler without transformer to power supply, please check the output voltage is 24VAC, in case of connecting to wrong power supply and that may break the unit. Do not unplug the power with wet hands.
2. This machine needs to be installed on a dental chair. The installed dental chair should meet the requirements of GB9706 safety regulations and YY0505 EMC, and obtain a legal medical device registration certificate and production license. .
3. Do not damage, modify, pull, excessively bend or twist the power cord, and do not place heavy objects on the power cord.
4. When the machine is restored after a power off, it will return to the working state before the power off. The operator should release the foot switch in time when the power is off.
5. This machine is a reusable product. Keep the machine clean before and after use. Before each use, the handpiece, scaling tip, torque wrench and other accessories must be disinfected and sterilized. It is recommended to disinfect and sterilize according to the recommended method in Chapter 5 of this manual.
6. Don't knock or rub the handpiece. Do not pull the cable while the device is working, to avoid damage to the cable.
7. Do not bend or polish the scaling tip. The scaling tip must be tightened to the handpiece with a torque wrench, and water mist must be generated during work.
8. Before each scaling, you should work outside the patient's mouth for more than 10 seconds under the condition of water to drain the water in the pipeline at the back of the handpiece.
9. When the scaling tip is damaged or worn out, the vibration intensity will decrease. The operator should replace the new scaling tip in time according to the clinical situation. It is not recommended to use the scaling tip after the wear reaches or exceeds 2mm, or after disinfection and sterilization has been used for more than 20 times. You can use the scaling tip wear comparison mark for comparison. The corresponding model's scaling tip wears out beyond the first line, and its power is basically unchanged; when the wear reaches between the first line and the second line, the power is as low as 80%; if worn to within the second line scale, the power will be low, it is recommended to replace the new tip.
10. Do not uninstall accessories such as tip, root canal adapter or root canal file when stepping on the foot switch and the machine is working.
11. The internal thread of the scaling tip produced by some manufacturers is rough, rusty, chipped, or uses other standard threads. When used with the external thread of the handpiece, it is easy to damage and slip, and even cause irreparable damage to the periodontal treatment device. Please use the adaptable tip produced by our company.
12. Choose the appropriate power according to different models of scaling tips.
13. Do not use impure water sources, and do not use normal saline instead of pure water sources.
14. Improper scaling and treatment of titanium implants, porcelain restorations, etc. can easily cause loosening of the adhesive, cracking of the porcelain restorations, or even cracking of the porcelain. The scaling or treatment of the oral cavity of such patients should be carefully considered.
15. Noise will be generated during the scaling process. Those who are sensitive to noise can wear earplugs by themselves.
16. Our company is specializing in the production of medical equipment. Only when the maintenance, repair and modification of the machine are carried out by our company or its authorized distributors, and the replacement parts are the parts of our company, and operate according to the instruction manual, we are responsible for its safety.
17. This equipment has electromagnetic interference. Do not use it around electronic surgery, and use the instrument with caution in an environment with strong electromagnetic interference.
18. This equipment does not contain toxic or hazardous substances and is discarded in accordance with the relevant laws and regulations on waste medical devices.

Contraindications

- 1) The hemophilia patient is forbidden to use this equipment.
- 2) The patients or doctors with heart pacemaker are forbidden to use this equipment.
- 3) The heart disease patient, pregnant woman and children should be cautious to use the equipment.

Symbol instruction

| Symbol | Instruction | Symbol | Instruction | Symbol | Instruction |
|---|---------------------------------|---|--|--|---|
|  | Caution | H_2O 0.01MPa-0.5MPa | Water entrance pressure:0.01MPa-0.5MPa |  | Waste electrical and electronic equipment |
|  | Recyclable |  | Class II equipment |  | Sterilizable in a steam sterilizer (autoclave) at 134°C |
|  | Date of manufacture |  | Manufacturer |  | Used indoor only |
|  | Type B applied part |  | Power adjustment |  | Fragile |
|  | Temperature limit: -20°C- +55°C |  | Atmospheric pressure limitation: 70kPa-106kPa |  | Humidity limitation: 10%-93% |
|  | Keep dry |  | Refer to instruction manual/ booklet |  | Unique device identifier |
|  | Medical device |  | Serial number | | |

1 Product introduction

Guilin Refine Medical is a high-tech enterprise integrating R&D, production and sales of dental products, with a complete quality assurance system.

1.1 Product overview

The ultrasonic scaler is used for cleaning and shaping the surface and root area on the teeth. They are also indispensable equipment for tooth disease prevention and treatment. The ultrasonic scaler is intended to be built in a dental unit which shall comply with IEC 60601-1 and IEC 80601-2-60. The product is supposed to be used at adults and children in hospitals and dental clinics, and should be used by trained and qualified dentist.

The ultrasonic scaler has following features:

- a) Elliptical vibration movement of the scaler tip, treatment and polishing are completed together.
- b) The amplitude of the scaler tip is small and painless treatment can be achieved.
- c) The handpiece is with LED light, which is more convenient for clinical operation.
- d) Automatic frequency tracking ensures that the device always works on the best frequency, stable and efficient performance.
- e) Adopt microcomputer fully automatic control, which is convenient and simple to operate with high efficiency.
- f) Detachable handpiece can be autoclaved under 134 °C and 0.22 Mpa.

1.2 Model

PT6/PT6 PRO

1.3 Application

The ultrasonic scaler is used for cleaning and shaping the surface and root area on the teeth.

1.4 Configuration

Refer to the packing list.

1.5 Composition

The ultrasonic scaler is composed of main unit, handpiece, cable, water pipe, scaling tip (optional), torque wrench and endo wrench (optional).

1.6 Accessories instructions

| | |
|-------------|--|
| Accessories | Replacement instructions |
| Handpiece | Can be used for a long time; replace when the output power drops significantly or does not work. |

| | | |
|-----------------|---------|--|
| Accessories | | Replacement instructions |
| Cable | | Can be used for a long time; replace when the power cord is cracked or non-conductive. |
| Water pipe | | Can be used for a long time; replace when the water pipe is cracked and leaked. |
| Torque wrench | | Can be used for a lone time; replace according to the instructions after damage. |
| Scaler tips | PT6 | Replace when it is reused up to 20 times or worn out to be unsuitable for use. For details, please refer to point 10 of the safety precautions. |
| | PT6 PRO | Replace when it is reused up to 20 times or worn out to be unsuitable for use. For details, please refer to point 10 of the safety precautions. |
| Root canal file | PT6 PRO | Replace when it is reused up to 20 times or worn out to be unsuitable for use. For details, please refer to point 10 of the safety precautions. |
| Endo wrench | PT6 PRO | Can be used for a lone time; replace according to the instructions after damage. |

1.7 Equipment safety classification

1.7.1 Operating mode: Continuous operation

1.7.2 Type of protection against electric shock: Class II

1.7.3 Degree of protection against electric shock: Type B applied part

1.7.4 Applied part of the equipment: Tip

1.7.5 Degree of protection against harmful ingress of water: protection degree against water (used on foot switch):IPX0

1.7.6 Degree of safety of application in the presence of a flammable anesthetic mixture with air or with oxygen or nitrous oxide: Equipment can not be used in the presence of a flammable anesthetic mixture with air or with oxygen or nitrous oxide.

1.8 Technical Parameters of each model

| | |
|---------------------|----------------|
| Parameters | PT6/PT6 PRO |
| Size | 57mm*60mm*35mm |
| Weight of main unit | 118g |
| Handpiece | HY-1L |
| Input | 24VAC 50Hz |
| Input Power | 20VA |

| | |
|---------------------------------|------------------------|
| Parameters | PT6/PT6 PRO |
| Main unit insurance | T0.5AL 250V |
| Primary tip vibration excursion | 1 μ m-90 μ m |
| Tip vibration frequency | 30kHz \pm 5kHz |
| Output power of tip | 3W-20W |
| Half-excursion force | 0.1N-5N |
| Water entrance pressure | 0.01-0.5MPa |
| Function | PT6: P PT6 PRO: P、E |
| Software version | 1.0.0 |

Note : Function Annotation: "P"means "Periodontal Function" ; "E"means "Endodontic Function".

1.9 Working condition

- 1) Environment temperature: +5 $^{\circ}$ C-+40 $^{\circ}$ C
- 2) Relative humidity: 30%-75%
- 3) Atmosphere pressure: 70kPa-106kPa
- 4) Temperature of the water at the inlet: not higher than +25 $^{\circ}$ C

2. Installation

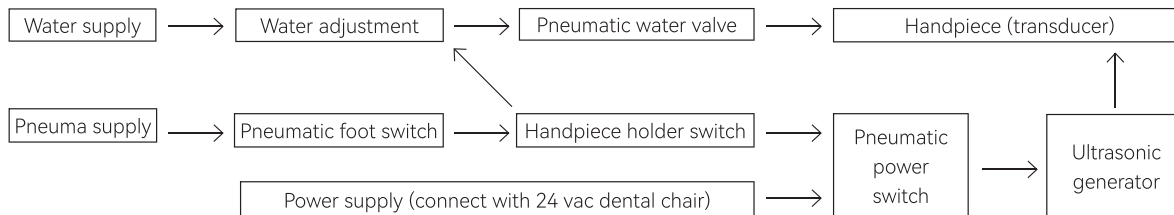

Picture 1

2.1 Working principle

A built-in ultrasonic periodontal treatment device. The components outside the handpiece must be installed inside the dental chair and used together with it. In addition, the dental chair required to be used must be electrified Indicating function. The main unit is an ultrasonic generator, and the handpiece is an ultrasonic transducer that can convert electrical energy into ultrasonic vibration mechanical energy. The periodontal treatment device is controlled by the foot switch of the dental chair and the control switch of the handpiece holder of the periodontal treatment device. The air source is disconnected when the handpiece is inserted into the handle holder, and the air source is connected when the handpiece leaves the handpiece holder.

Remove the handpiece from the handpiece holder, and the air source of the handpiece holder is now connected. Step on the pneumatic foot switch, and the pneumatic power switch, pneumatic water valve, ultrasonic generator, handle, and scaler tip are working at the same time, and the waterway is on.

2.2 Installation and connect of Main unit

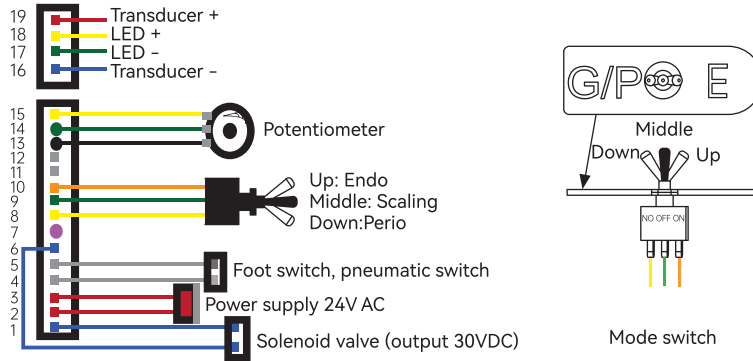

Picture 2

2.2.2 Connect the two wires 2 and 3 (red) to the 24VAC power supply. This circuit is not allowed to be used as a switch path.

2.2.3 Lead the two pins 4 and 5 (white and gray) to the pneumatic switch. This path is the signal path of the switch and cannot be short-circuited.

2.2.4 The two wires of pin 1 and pin 6 (blue) are circuit valve drive wires, which are usually not used. This output is 30V DC voltage, and cannot be connected to a power supply or switch, and cannot be short-circuited.

2.2.4 PT6 PRO series models 8, 9, 10 pins are the mode selection (yellow wire, green wire, orange wire), connected to the toggle switch, turn to the black wire marked "G/P" position

for ultrasonic cleaning Tooth mode or periodontal treatment mode, dial to the middle position of the green line is empty, dial to the orange line mark "E" position is the root canal washing mode.

2.2.5 Pins 13, 14, 15 are connected to the potentiometer for power adjustment. The power increases when the potentiometer is adjusted clockwise, and decreases when the potentiometer is adjusted counterclockwise.

2.3 Connecting for water (See Picture 3)

2.3.1 Put the cutting sleeve through the water pipe, keep it 10mm to 20mm away from the entrance.

2.3.2 Put the water pipe in the middle of the water exit connector(about 3mm), then push the cutting sleeve forward to the front edge of the water exit connector.

2.3.3 Pinch the cutting sleeve and the water pipe with your fingers, push them forward at the same time until they are wrapped into the water exit connector fully. Then the cutting sleeve is in the middle of the water exit connector.

Notice:

Cut off the forepart of the water pipe about 6 mm if repeat the above operation.

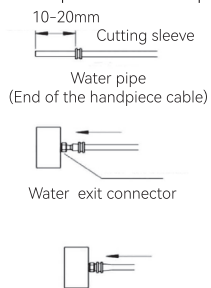

Picture 3

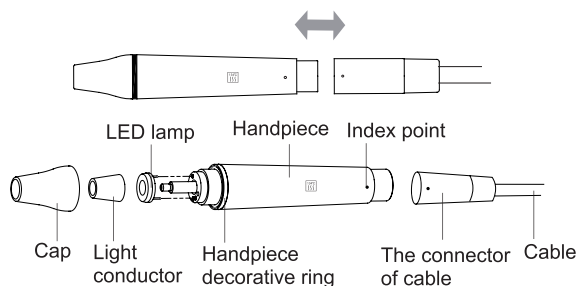

Picture 4

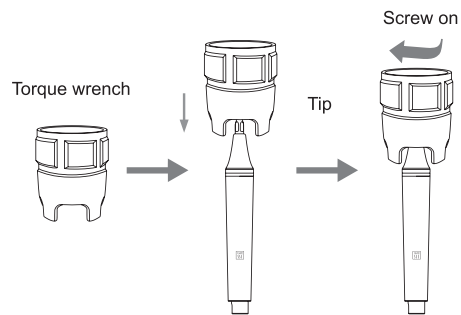

Picture 5

2.4 Instruction for main components of handpiece (Picture 4)

2.5 Instruction for using the wrench to install tip

⚠ 2.6 Notice

2.6.1 The power switch, valve and pneumatic switch(for foot switch) are supplied by the dental chair manufacture or dealer.

2.6.2 The fixation of the power potentiometer, the fixation of the mode switch (PT6 PRO model), and the lead-out of the silicone tube of the handle tail line need to be punched and

fixed on the tray of the dental chair by the manufacturer, distributor or end user of the condensation treatment table And elicit.

2.6.3 Keep enough room for cooling the circuit when installing the main unit on the dental unit.

2.6.4 Built-in periodontal treatment device occupies less space. The voltage supply is 24VAC, power \geq 20W.

2.6.5 Turn down the power grade to mini, and adjust the water volume to max.

3 Function and Operation

3.1 Scaling function

3.1.1 Choose the scaling tip according to the requirement, and fix the scaling tip with the wrench. (see picture 3) Please select a suitable power when using different type of tips (refer to "TABLE OF OPERATING POWER OF THE TIPS").

3.1.2 Step on the foot switch, the tip begins to vibrate, and the LED lamp (model with LED) on the top of the handpiece lights up. Release the foot switch, the LED lamp keep shining for 10 seconds.

3.1.3 The handpiece can be handled in the same gesture as a pen in hand.

3.1.4 Under normal working condition, the frequency of the tips is very high, light touch and a certain to-and-fro motion will eliminate the tartar without obvious heating, overexertion and overstay are forbidden.

3.1.5 Vibrating intensity: Using the potentiometer to adjust the vibrating intensity according to your need, usually adjust to the middle grade, and adjust the vibrating during the clinical treatment according to the patient's sensitivity and the rigidity of the tartar.

3.1.6 During clinical cleansing, please keep the side of the scaler tip in contact with the tooth surface at zero angle, without applying pressure, just let the scaler tip vibrate freely.

3.1.7 After finishing operation, keep the machine working for 30 seconds with the water supply to clean the handpiece and the tip.

3.1.8 Unscrew the scaling tip and sterilize it.

3.1.9 Instruction for using the wrench to install tip(See picture 5)

The torque wrench's structure is designed in special way which can control the strength of the scaling tip installation properly and correctly. It also can guarantee the operator screw or unscrew the scaling tip effectively and keep their hands away from being scratched.

Operation:

a) Take the end of tip into the torque wrench. b) Take the tip into the torque wrench then install or uninstall the scaling tip as picture 3 showed.

Installation: Hold the handpiece and turn the tip toward clockwise direction with the torque wrench. Turn one more circle when the tip stops, then the tip is installed.

Uninstallation: Hold the handpiece, turn the wrench toward anti-clockwise direction.

c) After each use, please put the torque wrench in the autoclave for disinfection;

d) After disinfection, due to the high surface temperature of the torque wrench, it can be used after the torque wrench is cooled to avoid burns;

e) When the torque wrench is not in use, place it in a ventilated and dry place and keep it clean.

4 Trouble shooting

4.1 Trouble analysis and shooting

| Fault | Possible causes | Solutions |
|---|---|---|
| The scaling tip doesn't vibrate and there is no water flowing out when stepping on the foot switch. | The power plug is in loose or wrong contact. | Plug it tightly |
| | Foot pedal is loose. | Plug it tightly |
| The scaling tip doesn't vibrate but there is water flowing out . | Scaling tip is loose. | Screw down the scaling tips (See picture 3) |
| | The connector of cable and circuit board is loose. | Contact with local dealer or manufacturer |
| | There is something wrong with detachable handpiece. | Contact with local dealer or manufacturer |
| | There is something wrong with cable. | contact with local dealer or manufacturer |
| The scaling tip vibrates, but there is no water flowing out. | Water supply of dental unit is off. | Check the water supply of the dental unit.(Note 1) |
| | There are impurities in solenoid valve. | Contact with local dealer or manufacturer |
| | There is no water coming out from the handpiece. | Clean the water pipe of the handpiece with multi-function syringes. |
| The handpiece still leaks water after the power is off | There are impurities in solenoid valve. | Contact with local dealer or manufacture |
| The handpiece generates heat. | The amount of spouting water is too little. | Turn the water control switch to a higher grade. |
| | Breakdown of the machine | Contact with local dealer or manufacturer |
| The amount of spouting water is too little. | The water pipe of handpiece is jammed. | Clean the water pipe of the handpiece with multi-function syringe. (Note 1) |
| | The water pressure is not high enough. | Enhance the water pressure. |
| The vibration of the tip becomes weak. | The tip hasn't been screwed tightly. | Screw down the scaling tip. |
| | The tip vibrates loose. | Screw down the scaling tip. |
| | The tip is damaged. (Note 2) | Change a new one. |

If the problem still can't be solved, please contact with local dealer or manufacturer.

4.2 Note

⚠(Note 1): Use the dental chair's multi-function syringe.

- 1) Disconnect the water pipe;
- 2) Press the power switch to turn on the power;
- 3) Insert the multi-function syringe of the dental chair into the water pipe;
- 4) Uninstall the working tip;
- 5) Step on the foot pedal;
- 6) Press the switch of the multi-function syringe to press the water into the machine to remove the impurities that jam the pipeline.

⚠(Note 2): If the following phenomena occur when the scaling tip has been tightened and water mist is sprayed out, the scaling tip is considered damaged:

- 1) The vibration intensity of the scaling tip and the degree of water atomization are significantly reduced.
- 2) The scaling tip makes a harsh "buzzing" sound when it is working.

5 Cleaning, disinfecting and sterilizing

5.1 Please conform to the recommendations of the manual "Reprocessing Instructions of Cleaning, Disinfecting and Sterilizing" delivered with your product regarding the procedure of cleaning, disinfecting, sterilizing and packing of the components. Follow present-day regulations enforced in the country about reprocessing. The use of scouring powder or an abrasive sponge will damage its surface.

5.2 The handpiece, scaling tips, endo file, endo wrench, torque wrench, LED lamp and Light conductor (the handpiece with LED lamp) can be sterilized.

⚠Notice:

- a) Clean the handpiece with compressed air before sterilization.
- b) Be sure that the scaling tip has been unscrewed from the handpiece and it cannot be sterilized with others.
- c) Please notice whether the outer of the handpiece is damaged during the treatment and sterilization. Don't smear any protective oil on the surface of handpiece.
- d) There are some waterproof "O" rings at the end of the handpiece. Please lubricate them with dental lube frequently, as sterilization and repeated pulling and inserting will reduce their using life. Change a new one once it is damaged or worn excessively.
- e) The following sterilizing methods are forbidden:
 - Boil in water.
 - Dip in iodine, alcohol and glutaraldehyde.
 - Bake in oven or microwave oven.

⚠Notice: We are not responsible for any damage caused in the above items.

6 Transportation, storage and maintenance

6.1 Transportation

- 6.1.1 Excessive impact and shake should be prevented in the transportation. Lay it carefully and lightly and don't invert it.
- 6.1.2 Don't put it together with dangerous goods during transportation.
- 6.1.3 Avoid solarization and getting wet in rain or snow during transportation.

6.2 Storage

- 6.2.1 Don't store the machine together with the articles that is combustible, poisonous, caustic, or explosive.
- 6.2.2 This equipment should be stored in a room where the relative humidity is 10%-93%, atmospheric pressure is 70kPa-106kPa, and the temperature is -20°C-+55°C.

6.3 Maintenance

- 6.3.1 The equipment should be handled carefully and lightly. Be sure that it is far from the vibration, and installed or kept in a cool, dry and ventilated place.
- 6.3.2 Please turn off the electrical source if not use it, if not use for a long time, please make the machine get through to the power and water once 3 months for five minutes.

7 Environmental protection

The instrument does not contain harmful ingredients. After the device is out of its service life, please dispose it in accordance with the Waste Electrical and Electronic Equipment (WEEE) directives and the medical waste disposal regulations of your country.

8 After service

- 8.1 After the machine is sold, if it cannot work normally due to quality problems, our company will be responsible for the repair with the warranty card. For specific items, please refer to the warranty instructions in the warranty card.
- 8.2 This machine does not contain self-maintained parts. All maintenance, adjustment, calibration and modification of technical parameters of the product can only be carried out by the company's technicians or special repair shops. If the customer needs to repair by himself, our company can follow the requirements to provide circuit diagrams, component lists, legends, calibration rules, or other information necessary to help the user's qualified technicians repair the equipment parts designated by our company, but our company will not bear the consequences.
- 8.3 The user must use the original accessories, please contact your local dealer or our company to purchase. It is forbidden to use related accessories of other brands to avoid damage to the equipment or other dangers.
- 8.4 After the handpieces, scaling tips and other accessories are damaged, users should not repair them by themselves. Please purchase new parts and replace them before use. If you need relevant information, please contact the manufacturer.

9 EMC - Declaration of conformity

9.1 Instructions for use

The ME EQUIPMENT or ME SYSTEM is used in hospitals or dental clinics.

Warning: Don't near active HF surgical equipment and the RF shielded room of an ME system for magnetic resonance imaging, where the intensity of EM disturbances is high.

Warning: Use of this equipment adjacent to or stacked with other equipment should be avoided because it could result in improper operation. If such use is necessary, this equipment and the other equipment should be observed to verify that they are operating normally.

Warning: Use of accessories, transducers and cables other than those specified or provided by the manufacturer of this equipment could result in increased electromagnetic emissions or decreased electromagnetic immunity of this equipment and result in improper operation.

Warning: Portable RF communications equipment (including peripherals such as antenna cables and external antennas) should be used no closer than 30 cm (12 inches) to any part of the equipment, including cables specified by the manufacturer. Otherwise, degradation of the performance of this equipment could result.

Note: The emissions characteristics of this equipment make it suitable for use in industrial areas and hospitals (CISPR 11 class A). If it is used in a residential environment (for which CISPR 11 class B is normally required) this equipment might not offer adequate protection to radio-frequency communication services. The user might need to take mitigation measures, such as relocating or re-orienting the equipment.

Warning: The use of cables and accessories other than those specified by the manufacturer may result in increased emission and/or decreased immunity.

List of all cables

| No | Name | Length | Shielded or not | Detachable or not | Note |
|----|-------------------------------|--------|-----------------|-------------------|------|
| 1 | Potentiometer wire | 0.6m | No | Yes | / |
| 2 | Toggle switch connecting wire | 0.6m | No | Yes | / |
| 3 | Handpiece cord | 2.0m | No | Yes | / |

Replaceable accessories

| No | Name | Model | Manufacturer | Connection method | Note |
|----|-----------|-------|--|-------------------|------|
| 1 | Handpiece | HY-1L | GUILIN REFINE MEDICAL INSTRUMENT CO., LTD. | plug | / |

Essential performance

The ultrasonic scaler has neither life sustaining functions nor diagnostic of life supporting functions.

The following functions are observed:

- Continuous working of ultrasound
- Continuous working of water flow
- Continuous light on handpiece

When abnormal performance is observed, supplementary measures may be necessary, such as reorientating or relocating the ultrasonic scaler.

9.2 Technical description

9.2.1. All necessary instructions for maintaining BASIC SAFETY and ESSENTIAL PERFORMANCE with regard to electromagnetic disturbances for the excepted service life:

- (1) Portable and mobile RF communications equipment may affect the performance of equipment, use of equipment should be avoided strong electromagnetic interference, and do not closer to mobile phone, microwave oven, etc.
- (2) Use of equipment adjacent to or stacked with other equipment should be avoided because it could result in improper operation. If such use is necessary, this equipment and the other equipment should be observed to verify that they are operating normally.
- (3) Except for the cables sold by manufacturers of as spare parts of internal components, the use of accessories and cables other than those specified or provided by the manufacturer may result in increased electromagnetic emissions or decreased electromagnetic immunity of this equipment and result in improper operation.
- (4) Use of accessories, transducers and cables other than those specified or provided by the manufacturer together with equipment could result in increased electromagnetic emissions or decreased electromagnetic immunity of this equipment and result in improper operation.

9.2.2. Guidance and manufacturer's declaration -electromagnetic emissions and Immunity

Table 1

| Guidance and manufacturer's declaration - electromagnetic emissions | |
|---|----------------|
| Emissions test | Compliance |
| RF emissions CISPR 11 | Group 1 |
| RF emissions CISPR 11 | Class A |
| Harmonic emissions IEC 61000-3-2 | Not Applicable |
| Voltage fluctuations / flicker emissions IEC 61000-3-3 | Not Applicable |

Table 2

| Guidance and manufacturer's declaration - electromagnetic Immunity | | |
|--|---|--|
| Immunity Test | IEC 60601-1-2 Test level | Compliance level |
| Electrostatic discharge (ESD) IEC 61000-4-2 | ±8 kV contact ±2 kV, ±4 kV, ±8 kV, ±15 kV air | ±8 kV contact ±2 kV, ±4 kV, ±8 kV, ±15 kV air |
| Electrical fast transient/burst IEC 61000-4-4 | ±2 kV power supply lines ±1 kV signal input/output 100 kHz repetition frequency | ±2 kV power supply lines Not applicable 100 kHz repetition frequency |
| Surge IEC 61000-4-5 | ±0.5 kV, ±1 kV differential mode ±0.5 kV, ±1 kV, ±2 kV common mode | ±0.5 kV, ±1 kV differential mode Not applicable |

| Guidance and manufacturer's declaration - electromagnetic Immunity | | |
|--|--|--|
| Voltage dips, short interruptions and voltage variations on power supply input lines IEC 61000-4-11 | 0 % UT; 0,5 cycle. At 0°, 45°, 90°, 135°, 180°, 225°, 270° and 315°. 0 % UT; 1 cycle and 70 % UT; 25/30 cycles; Single phase: at 0°. 0 % UT; 250/300 cycle | 0 % UT; 0,5 cycle. At 0°, 45°, 90°, 135°, 180°, 225°, 270° and 315°. 0 % UT; 1 cycle and 70 % UT; 25/30 cycles; Single phase: at 0°. 0 % UT; 250/300 cycle |
| Power frequency magnetic field IEC 61000-4-8 | 30 A/m 50Hz/60Hz | 30 A/m 50Hz/60Hz |
| Conducted RF IEC61000-4-6 | 3 V 0,15 MHz – 80 MHz 6 V in ISM bands between 0,15 MHz and 80 MHz 80 % AM at 1 kHz | 3 V 0,15 MHz – 80 MHz 6 V in ISM bands between 0,15 MHz and 80 MHz 80 % AM at 1 kHz |
| Radiated RF IEC61000-4-3 | 3 V/m 80 MHz – 2,7 GHz 80 % AM at 1 kHz | 3 V/m 80 MHz – 2,7 GHz 80 % AM at 1 kHz |
| NOTE U _T is the a.c. mains voltage prior to application of the test level. | | |

Table 3

| Guidance and manufacturer's declaration - electromagnetic Immunity | | | | | | |
|---|---------------------|-------------|---|------------------------------------|-------------------------------|-----------------------|
| | Test Frequency(MHz) | Band(MHz) | Service | Modulation | IEC 60601-1-2 Test Level(V/m) | Compliance level(V/m) |
| Radiated RF IEC61000-4-3 (Test specifications for ENCLOSURE PORT IMMUNITY to RF wireless communications equipment) | 385 | 380 – 390 | TETRA 400 | Pulse modulation 18 Hz | 27 | 27 |
| | 450 | 430 – 470 | GMRS 460,FRS 460 | FM ± 5 kHz deviation 1 kHz sine | 28 | 28 |
| | 710 | 704 – 787 | LTE Band 13,17 | Pulse modulation 217 Hz | 9 | 9 |
| | 745 | | | | | |
| | 780 | | | | | |
| | 810 | | | | | |
| | 870 | 800 – 960 | GSM 800/900,TETRA 800,iDEN 820,CDMA 850,LTE Band 5 | Pulse modulation 18 Hz | 28 | 28 |
| | 930 | | | | | |
| | 1720 | | | | | |
| | 1845 | 1700 – 1990 | GSM 1800,CDMA 1900,GSM 1900,DECT,LTE Band 1, 3,4, 25; UMTS | Pulse modulation 217 Hz | 28 | 28 |
| | 1970 | | | | | |
| | 2450 | 2400 – 2570 | Bluetooth,WLAN,802.11 b/g/n,RFID 2450,LTE Band 7 | Pulse modulation 217 Hz | 28 | 28 |
| | 5240 | 5100 – 5800 | WLAN 802.11 a/n | Pulse modulation 217 Hz | 9 | 9 |
| | 5500 | | | | | |
| 5785 | | | | | | |

Table 4

| Guidance and manufacturer's declaration - electromagnetic Immunity | | | | |
|---|----------------|--------------------------|-------------------------------|-----------------------|
| | Test Frequency | Modulation | IEC 60601-1-2 Test Level(A/m) | Compliance level(A/m) |
| Radiated RF IEC61000-4-39 (Test specifications for ENCLOSURE PORT IMMUNITY to proximity magnetic fields) | 30 kHz | CW | 8 | 8 |
| | 134,2 kHz | Pulse modulation 2.1 kHz | 65 | 65 |
| | 13,56 kHz | Pulse modulation 50 kHz | 7,5 | 7,5 |

Attachment. Reprocessing instructions of cleaning, disinfecting and sterilizing

1. BEGINNING WORK!

1.1 Please read these operating instructions carefully as they explain all the most important details and procedures. Please pay special attention to the safety precautions. Always keep this instruction close at hand.

1.2 To prevent injury to people and damage to property, please heed the corresponding directives.

1.3 The instructions in this manual are only applicable to the equipment which it was delivered with.

2. INTRODUCTION

2.1 These reprocessing instructions provide instructions for cleaning, disinfection, sterilization and packaging of manufacturer reusable products intended to be reprocessed in medical facilities.

2.2 The goal of reprocessing reusable products is to reduce bioburden and to achieve sterility of those products in order to eliminate the risk of product reuse related infection. Decisions regarding cleaning, disinfecting or sterilizing manufacturer's medical and dental instruments are based on the potential risk of infection associated with their use.

2.3 It is recommended to use steam sterilization.

2.4 Remember that sterilization or high-level disinfection cannot be achieved unless the elements of the assembly are cleaned first.

2.5 If you find that the reprocessing instructions from the manufacturer

seem to be inadequate, please inform manufacturer about those inadequacies.

2.6 We encourage you to report adverse events related to device reprocessing. Report such events directly to manufacturer.

3. REPROCESSING - INSTRUCTIONS FOR REUSABLE PRODUCTS

3.1 The instructions are binding for the reprocessing of all reusable products (Here after called "products") of manufacturer. When necessary, additional product-specific instructions are included with the product to provide additional information.

⚠ Important: Before use, carefully read the operating instructions of the manufacturer instrument and devices with which the product will be used.

3.2 Reusable products must be cleaned, disinfected and sterilized prior to first use. Reprocessing procedures have only limited implications to this device. The limitation of the numbers of reprocessing procedures is therefore determined by the function / wear of the device. From the processing side there is no maximum number of allowable reprocessing. The device should no longer be reused in case of signs of material degradation.

⚠ In case of damage the product should be reprocessed before sending back to the manufacturer for repair.

4. PREPARATION - Basic principles

4.1 It is only possible to carry out effective sterilization after the completion of effective cleaning and disinfection. Please ensure that, as part of your responsibility for the sterility of products during use, only sufficiently validated equipment and product-specific procedures are used for cleaning/disinfection and sterilization, and that the validated parameters are adhered to during every cycle.

4.2 Please also observe the applicable legal requirements in your country as well as the hygiene regulations of the hospital or clinic. This applies especially with regard to the additional requirements for the inactivation of prions.

5. POST-OPERATIVE TREATMENT

The post-operative treatment must be carried out immediately, no later than 30 minutes after the completion of the operation. Additional information, while necessary, is provided in the respective product-specific usage instructions.

Steps:

1. Rinse away any surface soiling on the product with distilled deionized water or with a cleaning agent.
2. Rinse through all lumina (E.g. irrigation and aspiration connection) at least 3 times in the normal direction of flow (no back rinsing) using a disposable syringe (min. volume 50 ml) filled with distilled/deionized water applied to the back nozzle.
3. An aldehyde-free cleaning and disinfection solution that is compatible with the products may also be used as an alternative rinsing solution.

In such cases, it is necessary to rinse thoroughly afterwards at least 3 times with distilled, or deionized water.

6. CLEANING/DISINFECTION:

6.1 MECHANICAL REPROCESSING

Disinfection must be performed no later than 2 hours after the cleaning phase.

A machine cleaning and disinfection method should always be used for cleaning / disinfection because of the increased effectiveness of this method.

6.2 MECHANICAL CLEANING AND DISINFECTION

6.2.1 Thermal disinfection should be used if this function is available on your disinfectant. Use if possible a disinfecting cycle compliant with the standard EN ISO 15883.

6.2.2 Note that there is a risk of disinfectant residue on products when using chemical disinfectants.

6.2.3 Ensure the following criteria are met when selecting a disinfectant system:

- Disinfectant is proven effective through testing (E.g. FDA approved or CE marked / EN ISO 15883 compliant).
- Disinfectant has suitable baskets to hold small fragile products and has rinsing connections for the attachment to product lumina.
- The cleaning program is suitable for products to be processed and the rinsing cycle is sufficient.
- Only low microbe count (<10 cfu/ml) distilled or deionized water is used for all rinsing steps. (E.g. Aqua purificata, as per the specifications of Pharm. Eur. or USP).
- Air used for drying is HEPA filtered.

•Disinfectant is serviced and checked on a regular basis.

6.2.4 Ensure the following criteria are met when selecting a cleaning and disinfection agent:

- Chemicals are compatible with products.
- With non-thermal disinfection, a suitable disinfectant with tested effectiveness (E.g. FDA approved or CE marked), that is compatible with the cleaning agent, must be used.

⚠️ Concentrations and contact times specified by the manufacturer of the cleaning and disinfection agent must be followed. Only freshly prepared solutions may be used.

6.2.5 Steps for mechanical cleaning and disinfection with a disinfectant

1) Load the WD with the instruments on the tray and start the WD with a full load. Run the cleaning cycle of the "surgical instrument" programme in accordance with the manufacturer's instructions.

Instrument cleaning program:

- pre-wash (5 minutes, ambient temperature water)
- cleaning (5 minutes, 0.5% neutral pH detergent, 40°C)
- rinse I (1 minute, ambient temperature water)
- rinse II (1 minute, ambient temperature water)
- disinfection (2.5 minutes, pure water 93°C)

2) Immediately after the cleaning cycle, interrupt the program and unload the samples.

3) After cleaning in the WD, examine the instruments visually.

4) Carefully place the products in the disinfection basket. Fastening of the products is only permissible if they are freely moveable in the fixture. The products are not permitted to make contact with one another.

5) Using a suitable rinsing adaptor, connect the product lumina to the rinsing connections of the disinfectant.

6) Start the program.

7) Remove the products from the disinfectant and start the inspection (see section Inspection and maintenance) after the program ends.

8) Wrap the products directly following disinfection and drying (see section Packaging and sterilization). If necessary, repeat drying of the product in a clean place.

7. INSPECTION AND MAINTENANCE

If stains are still visible on the product after cleaning/disinfection, the entire cleaning/disinfection procedure must be repeated. Products with visible damage, chip/flake loss, corrosion or bent out of shape must be disposed of (no further use is permissible).

8. PACKAGING AND STERILIZATION

⚠️ Do not exceed the maximum number of sterilization cycles.

Only cleaned and disinfected products are permitted to be sterilized. Prior to sterilization, the products need to be placed in a suitable sterilization container:

- Compliant with EN ISO 11607,
- Resistant to 138°C, with adequate steam permeability,
- Maintained on a regular basis.

If double, single-use sterilization packaging (double bag) is to be used, this must also comply with EN ISO 11607 and be suitable for steam sterilization (temperature resistant to 138°C with adequate steam permeability).

Use only the following listed steam sterilization procedures for

sterilization; other sterilization procedures are not permissible:

- Fractional pre-vacuum procedure (steam sterilization with repetitive pre-vacuum.)
- Steam sterilizer in accordance with EN 13060 or EN 285 validated in compliance with EN ISO 17665,
- Maximum sterilization temperature 138°C,
- Sterilization time at least 3 min. at 134°C (fractional pre-vacuum procedure),
- Sterilization at 134°C for a maximum of 20 minutes is permissible.
- Recommended sterilization cycles of handpiece: 300 cycles

⚠ The hot-air sterilization and radio-sterilization procedure may not be used (as it causes the destruction of products).

⚠ The manufacturer assumes no responsibility for the use of other sterilization procedures (E.g. ethylene oxide, formaldehyde and low temperature plasma sterilization). In such cases, please observe the respective valid standards (EN ISO 14937/ANSI AAMI ISO 14937 or the procedure-specific standard) and verify the suitability and effectiveness in principle of the procedure (if necessary, including investigations on sterilizing agent residue), taking into account the specific product geometry as part of the validation.

9. SERVICE LIFE

The products have been designed for a large number of sterilization cycles. The materials used in their manufacture were selected accordingly. However with every renewed preparation for use, thermal and chemical stresses will result in aging of the products.

If the number of permissible re-sterilization cycles is restricted, this will

be pointed out in the product specific instructions.

The use of ultrasound baths and strong cleaning and disinfection fluids (alkaline pH > 9 or acid pH < 5) can reduce the life span of products. The manufacturer accepts no liability in such cases.

The products may not be exposed to temperatures above 138°C.

Note: We reserve the rights to change the design of the equipment, the technique, fittings, the instruction manual and the content of the original packing list at any time without notice. If there are some differences between blueprint and real equipment, take the real equipment as the norm.

Shelf life: 10 years, the date of manufacture see product label.