

Ultra λ Ultrasonic Activator

USER MANUAL

Changzhou Sifary Medical Technology Co.,Ltd.

Content

1. Scope of Ultra X	3
1.1 Parts Identification.....	3
1.2 Components and Accessories.....	4
2. Symbols Used.....	5
3. Before Use	6
3.1 Scope of application.....	6
3.2 Contraindications.....	6
4. Setting up the Ultra X.....	8
4.1 Installing the sleeve.....	8
4.2 Installing the tip.....	8
4.3 Tip Removal	8
4.4 Connecting the adapter	9
5. Use Interface	10
5.1 Panel key	10
6. Operation	11
6.1 Charge.....	11
6.2 Operation	13
7. Cleaning, Disinfection and Sterilization	15
7.1 Foreword.....	15
7.2 General recommendations.....	15
7.3 Autoclavable Components	15
7.4 Disinfection components.....	19
8. Error Warning	20
9. Troubleshooting.....	21
10. Technical Data	22
11. EMC Tables.....	23
12. Statement.....	27

1.Scope of Ultra X



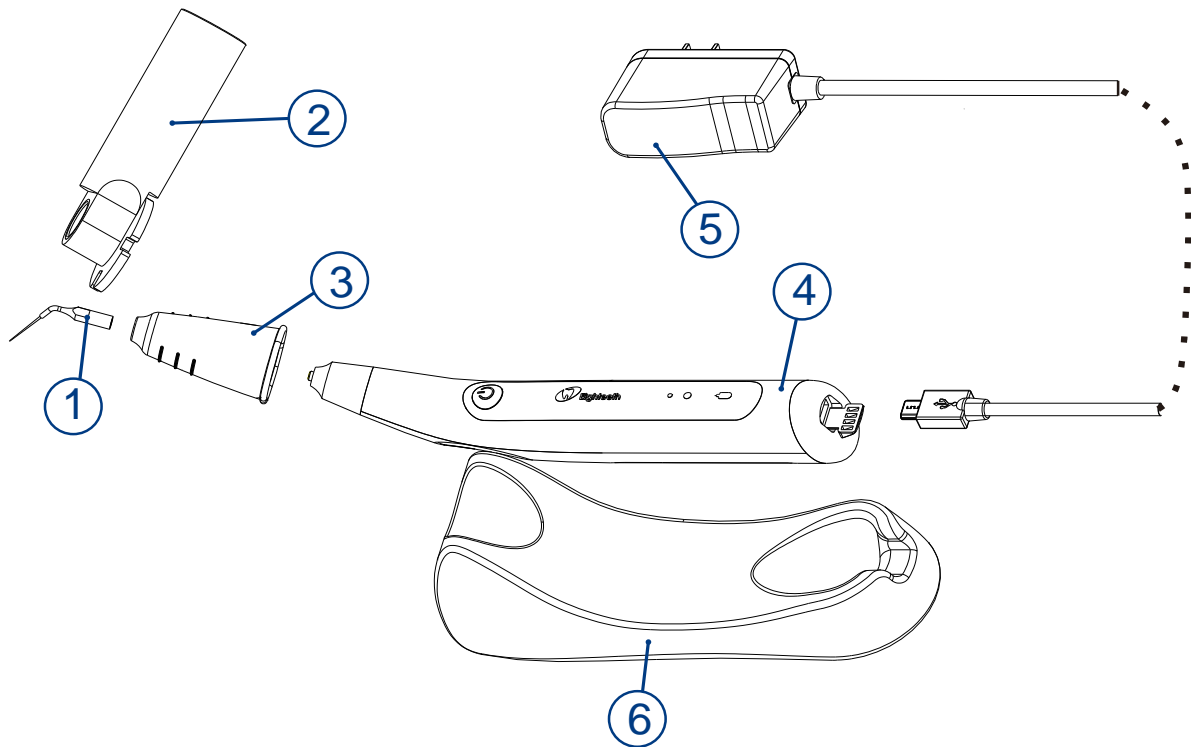

1.1 Parts Identification





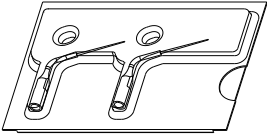
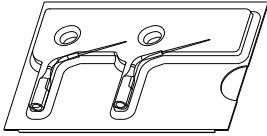
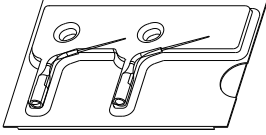
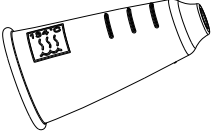

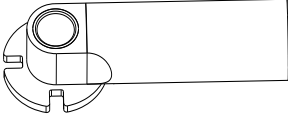









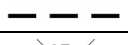

Accessories list

1. Tips(6pcs)
2. Wrench
3. Insulating sleeve
4. Ultra X handpiece
5. Adapter
6. Handpiece Base

1.2 Components and Accessories

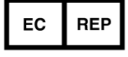
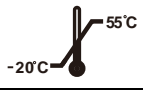
<p>Ultra X handpiece (1pcs) ORDER CODE: 6251001</p> 	<p>Tip: S21(1 pcs) ORDER CODE: 6251041</p> 	<p>Tip: G18 (1 pcs) ORDER CODE: 6251042</p> 
<p>Tip: B18 (1 pcs) ORDER CODE: 6251043</p> 	<p>Insulating sleeve (1 pcs) ORDER CODE: 6204002</p> 	<p>Adapter (1 pcs) ORDER CODE: 6016001</p> 
<p>Wrench (1 pcs) ORDER CODE: 6251007</p> 	<p>Handpiece base(1pcs) ORDER CODE: 6005002</p> 	<p>User manual (1 pcs) ORDER CODE: 6235001</p>

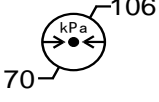
2. Symbols Used

 Warning	If the instructions are not followed properly, operation may lead to hazards for the product or the user/patient.
 NOTE	Additional information, explanation of operation and performance.
	Serial number
	Catalogue number
	Manufacturer
	Date of manufacture
	Class II equipment
	Type B applied part
	CE marking
	Direct current
	WEEE directive marking
	Keep dry
	Consult instructions for use
	Can be autoclaved up to a maximum temperature of 134° Celsius
	Authorized Representative in the European Community
	Temperature limitation
	Humidity limitation
	Atmospheric pressure limitation
	Washer-disinfector for thermal disinfection
	Manufacturer Logo

3. Before Use

3.1 Scope of application

Ultra X is used in endodontic treatment by application of ultrasonic energy. The Ultra X can provide the energy for tip oscillation and vibration in frequency (45KHz±5KHz) required to create sufficient acoustical streaming and cavitation necessary to effectively clean, penetrate, and remove vapor lock. A cleaned root canal system makes for better outcomes and reduces retreatment rate.

This device must only be used in hospital environments, clinics or dental offices by qualified dental personnel and not used in the oxygen-rich environment.

3.2 Contraindications

The Ultra X is contraindicated in cases where patient/user carry medical implants such as pace makers or cochlear implants etc.

Do not use the device for implants or other non-endodontic dental procedures.

Safety and effectiveness have not been established in pregnant women and children.



Warning

Read the following warnings before use:

1. The device must not be placed in humid surroundings or anywhere where it can come into contact with any type of liquids.
2. Do not expose the device to direct or indirect heat sources. The device must be operated and stored in a safe environment.
3. The device requires special precautions with regard to electromagnetic compatibility (EMC) and must be installed and operated in strict compliance with the EMC information. In particular, do not use the device in the vicinity of fluorescent lamps, radio transmitters, remote controls and do not use this system near the active HF Surgical Equipment in the hospital. Portable RF communications equipment (including peripherals such as antenna cables and external antennas) should be used no closer than 30 cm (12 inches) to any part of the E-connect S, including

cables specified by the manufacturer. Otherwise, degradation of the performance of this equipment could result. Do not charge, operate or store at high temperatures. Comply with the specified operating and storage conditions.

4. Gloves and a rubber dam are compulsory during treatment.
5. If irregularities occur in the device during treatment, switch it off. Contact the agency.
6. Never open or repair the device by yourself, otherwise, void the warranty.

4. Setting up the Ultra X

4.1 Installing the sleeve

Always use a silicone sleeve.

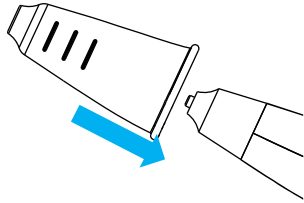

4.2 Installing the tip

Make sure the thread on the tip is aligning to the stud of the handpiece. Plug them together and turn it carefully

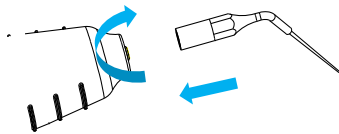

NOTE

- Only the original tip can be used.
- The Activator tips are not sterile when delivered and must be autoclaved before being used for the first time
- Clean and disinfect the Activator tips before every use

Tighten the tip clockwise with provided wrench until the tip is secure.

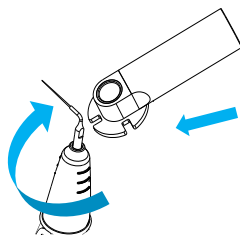

When you set the tip on the device, the tip can be set within a range of 10°, therefore, do not tighten the tip in excess.

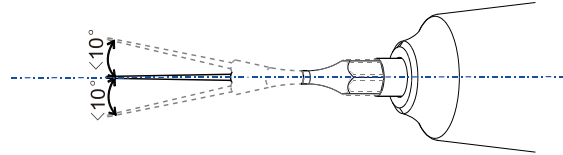

Warning

- Inspect the tip before inserting. Do not use the damaged tip.
- Make sure the device is stopped when inserting and removing tips.
- Pull the tip gently to make sure that the tip is secure in handpiece properly, otherwise it may pop out and hurt the patient.

4.3 Tip Removal

Loosen the tip counterclockwise with provided wrench until the tip is shedding.

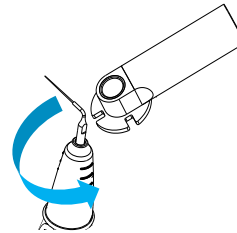

Warning

- Estimated case number of uses per tip: 20, taking 2 root canals per case as a reference.

Be careful when inserting and removing tips to avoid injury to fingers.

4.4 Connecting the adapter

Connect the USB cable to the handpiece power connector, and plug the other end into a power outlet. The Power LED on the handpiece will flash (yellow).

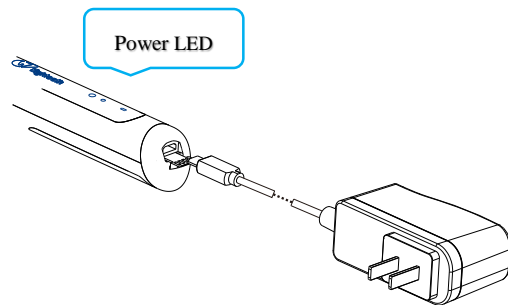

NOTE

Only the original adapter can be used.

Do not use the device while charging.

Handpiece base is recommended to be used to place the Ultra X to protect the tip when the device is not in use.

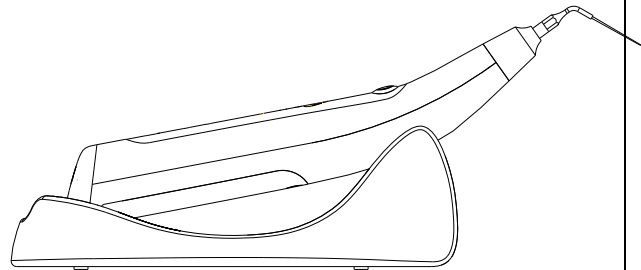

5.Use Interface

5.1 Panel key

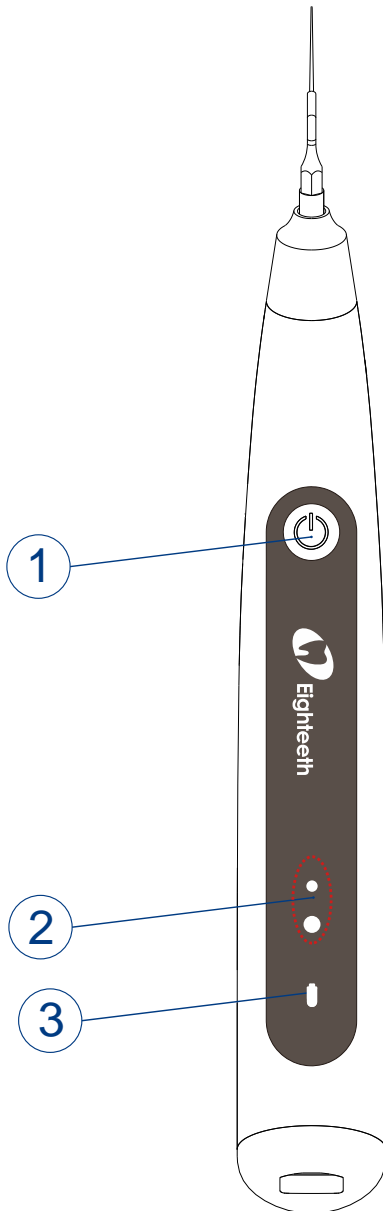

① Main switch

② Mode LED

③ Power LED

Turn Power On

Press to turn on the device.

Output Power Adjustment

Long press can switch to “High Output Power Mode” or “Low Output Power Mode” during working.

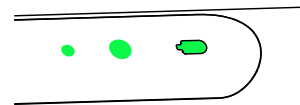

HIGH OUTPUT POWER MODE

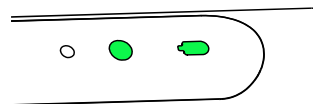



LOW OUTPUT POWER MODE

Turn Power Off





Press to turn off the output during working. The Ultra X will turn off the output and enters the standby state. The Ultra X will shut down after 1 minute of standby automatically.

6.Operation

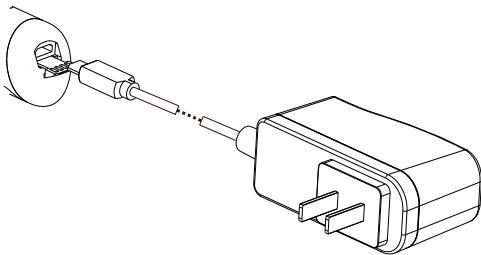

6.1 Charge

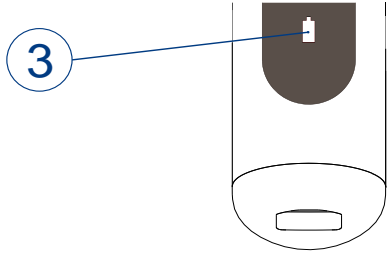
<p>Power LED light up in “GREEN”</p>	<p>Battery power is >50%.</p>
<p>Power LED light up in “YELLOW”</p>	<p>Battery power is 15%~50%.</p>
<p>Power LED light up in “RED”</p>	<p>Battery power is <15%.</p> <div style="background-color: #f0f0f0; padding: 5px;">  NOTE If the power is less than 15%, the device must be recharged within 30 days, otherwise the battery will be damaged. </div>
<p>Power LED flashes in “RED”</p>	<p>Battery power is <5%. The device will stop working and have voice prompt, please charge immediately.</p> <div style="background-color: #f0f0f0; padding: 5px;">  NOTE The remaining amount of battery mark indicates a voltage. When a load is applied to the handpiece, the remaining amount of battery mark appears to become lower </div>

6 Operation

	<p>Connect the adapter to the handpiece.</p> <p> NOTE Only the original adapter can be used.</p>
	<p>Charging indication appears on the power LED, and flashes in “YELLOW”(③), when the battery is fully charged or in a state near full charge, the flash will stop and light up in “GREEN” (③).</p> <p>Fully charged will take about 4 hours, depending on residual battery power and battery state.</p> <p>It can be recharged 300-500 times, depending on the operating conditions of the device.</p> <p> NOTE When changing, other function will forcibly stop and get in to the charging mode.</p>
<p> Warning</p> <p>Do not change the battery, only trained technician or distributor can change the battery, the electronic parts will be damaged if use a wrong battery or install with a wrong way.</p>	

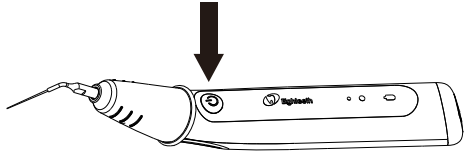
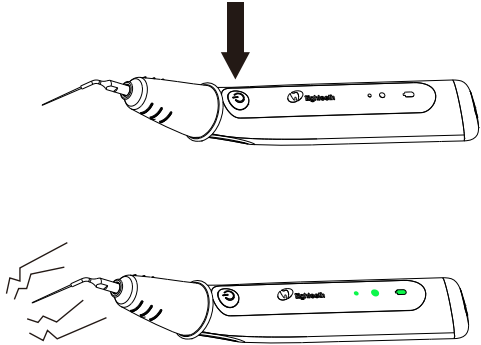
6.2 Operation

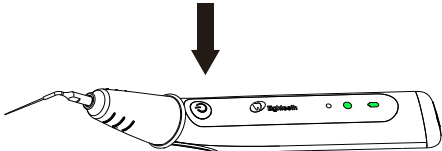
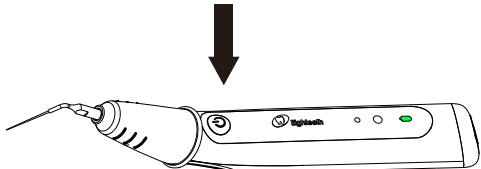
	<p>Turn on the device: Press on main switch to turn on the device. Power LED will light up.</p>
	<p>Turn on the device: press on main switch to turn power on. Power LED and Mode LED will light up.</p> <div style="background-color: #f0f0f0; padding: 10px; border: 1px solid #ccc;"> <p> NOTE</p> <ul style="list-style-type: none"> ● Once the device is started, it will vibrate at the ultrasonic frequency. Do not touch the tip at this time. ● Do not let the device vibrate for a long time without load. ● Ensure that there is sufficient rinsing fluid for cooling during use. Do not operate without flushing fluid. ● Ensure that the tip is upper 2mm from working length when moving the tip up and down ● Activate intracanal solution for 30-60 seconds for optimal canal cleanliness </div>
	<p>Long press on main switch for more than 1s during working, you can switch the output power in cycle.</p>
	<p>Turn off the device: Press on main switch to turn off the device. The Ultra X will turn off the output and enters the standby state. The Ultra X will shut down after 1 minute of standby automatically.</p>

The Ultra X will automatically shut down after 3 minutes of continuous operation; In addition, the machine has a timed reminder function, and there is a beep every 5s during the work.



Warning

- Use the Ultra X outside the oral cavity to make sure that the device is functioning properly.
- Replace the tip on time to avoid file separation within the canal. Tips may separate because of metal fatigue.
- Heavy force / hand pressure on handpiece while using may even cause tip separation.



NOTE

- If there is any abnormal functioning, stop using the device and report to the company.
- This device is not suitable for all types of root canals. Do not use this device on extremely deformed root canal.
- Gloves and a rubber dam are compulsory during treatment.
- Do not forget to remove the tip from the device after its use.

7. Cleaning, Disinfection and Sterilization

7.1 Foreword

For hygiene and sanitary safety purpose, the components (Tips, Wrench, and Insulating sleeve) must be cleaned, disinfected and sterilized before each usage to prevent any contamination. This concerns the first use as well as the subsequent uses.

Comply with your national guidelines, standards and requirements for cleaning, disinfection and sterilization.

7.2 General recommendations

7.2.1 The user is responsible for the sterility of the product for the first cycle and each further usage as well as for the usage of damaged or dirty instruments, where applicable after sterility.

7.2.2 For your own safety, please wear personal protective equipment (gloves, safety glasses, etc.).

7.2.3 Use only a disinfecting solution which is approved for its efficacy (VAH/DGHM-listing, CE marking, and FDA approval) and in accordance with the DFU of the disinfecting solution manufacturer.



7.2.4 The water quality has to be convenient to the local regulations especially for the last rinsing step or with a washer-disinfector.



7.2.5 Thoroughly clean and wash the components before autoclaving.

7.2.6 Do not clean the tips and wrench with an ultrasonic cleaning device.

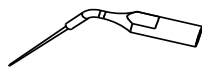
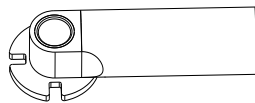
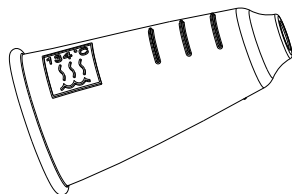

7.2.7 Do not use bleach or chloride disinfectant materials.

7.3 Autoclavable Components

Autoclavable Components		
Tip 	Wrench 	Insulating sleeve 
<div style="display: flex; align-items: center;">  <p>WARNING</p> </div> <ul style="list-style-type: none"> ● Only the components above can be autoclaved. ● Before first use and after each use, sterilize the above components. 		
STEP NO.	INSTRUCTIONS	
1	Initial treatment	Immediately after using, wipe gross

	at point of use	<p>contaminations from the components, and put them in container for transportation. Prepare the components directly after treatment.</p> <p> WARNING</p> <p>Do not submerge the components or wipe them with any of the following functional water (acidic electrolyzed water, strong alkaline solution, or ozone water), medical agents (glutaral, etc.), or any other special types of water or commercial cleaning liquids. Such liquids may result in metal corrosion and adhesion of the residual medical agents to the components.</p>
2	Preparation before cleaning	<p>Remove and disconnect the components (Tips, Wrench, and Insulating sleeve) before cleaning. Refer to "Chapter 4- Setting up the Ultra X" of this manual for disassembly instructions.</p> <p> WARNING</p> <p>Observe suitable personal protective measures.</p>
<p>The following Step 2 to Step 4 are operated in a washer-disinfector:</p> <p> WARNING</p> <ul style="list-style-type: none"> ● Use only approved washer-disinfectors according to EN ISO 15883, maintain and calibrate it regularly. ● Follow instructions and observe concentrations given by the manufacturer (see general recommendations). ● Sufficient rinsing step should be available in purified water (max 10 germs/ml and max 0.25 endotoxin units/ml) ● Avoid any contact between the tips and any instrument, kit, support or container. ● Make sure the components are dry before moving to the #5 step. 		
3	Cleaning: Automated	<p>Carefully put the components (Tips, Wrench, and Insulating sleeve) into the washer-disinfector and set the parameters as follows:</p> <ul style="list-style-type: none"> - Pre-cleaning: water temperature <30°C, 2

		min; - Cleaning: water temperature 45°C, 5 min; use an enzyme detergent solution (mild and aldehyde free solution) which is suitable to be used with washer-disinfector, and use in accordance with the IFU of the detergent solution manufacturer; - Rinsing: water temperature 45°C, 1 min (rinsing twice).
4	Disinfection: Thermal	Thermal disinfection at least 5 min at 90°C /194° F, make sure A0 value ≥3000.
5	Drying	Heat: 20min, 90°C/194° F
6	Maintenance and Inspection	Inspect components and sort out those with defects. Dirty components must be cleaned and disinfected again.
7	Packaging	Pack each component in a separate steam-sterilization pouch. <div style="background-color: #f0f0f0; padding: 10px; border: 1px solid #ccc;">  WARNING <ul style="list-style-type: none"> ● Check the validity period of pouch given by the manufacturer to determine the shelf life. ● Use pouches which resist to a temperature up to 141°C(286°F) and in accordance with EN ISO 11607. </div>



8	Sterilization	<p>Steam sterilization at 134 °C at least 6 minutes. Minimum drying time after sterilization: 10 minutes.</p> <div style="background-color: #f0f0f0; padding: 10px;">  WARNING <ul style="list-style-type: none"> ● Use only approved autoclave devices according to EN 13060 or EN 285. ● Use a validated sterilization procedure according to ISO 17665. ● Respect the maintenance procedure of the autoclave device given by the manufacturer. ● Use only this recommended sterilization procedure. ● Control the efficiency (packaging integrity, no humidity, color change of sterilization indicators, physicochemical integrators, digital records of cycles parameters). ● The sterilization procedure must comply with ISO 17665. ● Waiting for cooling before touching. </div>
9	Storage	<p>Keep the components in sterilization packaging in a dry and clean environment.</p> <div style="background-color: #f0f0f0; padding: 10px;">  WARNING <ul style="list-style-type: none"> ● Sterility cannot be guaranteed if packaging is open, damaged or wet. ● Check the packaging before using it (packaging integrity, no humidity and validity period). </div>



NOTE

The instructions provided above have been validated by the manufacturer of the medical device as being capable of preparing a medical device for use. It remains the responsibility of the processor to ensure that the processing, as actually performed using equipment, materials and personnel in the processing facility, achieves the desired result. This requires verification and/or validation and routine monitoring of the process. Likewise, any deviation by the processor from the instructions provided should be properly evaluated for effectiveness and potential adverse consequences.

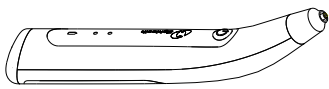
7.4 Disinfection components

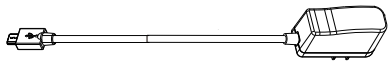
Handpiece	Handpiece Base	Adapter
		

Wipe all the surfaces with a cloth lightly moistened with Ethanol for Disinfection (Ethanol 70 to 80vol%) at least 2min, repeat for 5 times.



NOTE

- Do not use anything except Ethanol for Disinfection (Ethanol 70 to 80 vol%).
- Do not use too much ethanol as it's going into machine and damage the components inside.

8.Error Warning

The device stops working and beeping with Power LED flashes in red.	The power is very low. Charge it immediately
Power LED lights up in "BLUE"	The main board is broken. Please stop using the device immediately and remove the battery. Contact your local distributor.

9.Troubleshooting

When trouble is found, check the following points before contacting your distributor. If none of these are applicable or the trouble is not remedied even after action has been taken, the product may have failed. Contact your distributor.

Problem	Cause	Solution	Ref. chap
The power is not turned on.	The battery is run down.	Charge the battery.	6.1
	The time to press the main switch is too short.	Press the main switch more than 0.5 seconds.	6.2
The Power LED does not light up when charging.	Use a wrong adapter.	Use the original adapter.	6.1
	There is no electricity in the outlet.	Check the connection.	
	The adapter is not connected.	Check the connection.	/
	The plug of the adapter is not inserted into the outlet.	Check the connection.	/
The Power LED lights up in "BLUE".	The main board is broken.	Contact your distributor.	/
The LEDs on handpiece do not light up.	The handpiece is broken.	Contact your distributor.	/
Tip does not vibrate.	Tip is not installed in place.	Check the installation.	/
	Tip is broken.	Replace a new tip.	
	The main board is broken.	Contact your distributor.	/
There is no beep.	The main board is broken.	Contact your distributor.	/
There is beeping	Battery power is very low.	Charge the battery immediately.	6.1

10. Technical Data

Manufacturer	Changzhou Sifary Medical Technology Co., Ltd.
Model	Ultra X
Dimensions	22cm x 18cm x 7 cm \pm 1cm (package)
Weight	750g \pm 10%
Power supply	Lithium ion battery: 3.7V, 1500mAh \pm 10%
Charger power supply	AC100-240V, \pm 10%
Charger power output	5V \therefore 1A
Frequency	50/60Hz, \pm 10%
Charger nominal power input	5.5VA
Output frequency	45KHz \pm 5KHz
Electrical safety class	Class II
Applied part	B
Ambient conditions	Use: in enclosed spaces Ambient temperature: 10°C ~ 35°C Relative humidity: <80%; non-condensing at 0° Operating altitude < 3000m above sea level
Transport and storage conditions	<ul style="list-style-type: none"> • Ambient temperature: -20 °C ~ +55 °C • Relative humidity: 20% - 80 %, non-condensing at > 40 °C • Atmospheric pressure: 70 kPa - 106 kPa

11.EMC Tables

Guidance and manufacturer's declaration – electromagnetic emissions		
The Ultra X is intended for use in the electromagnetic environment specified below. The customer or the user of the Ultra X should assure that it is used in such an environment.		
Emissions test	Compliance	Electromagnetic environment - guidance
RF emissions CISPR 11	Group 1	The Ultra X uses RF energy only for its internal function. Therefore, its RF emissions are very low and are not likely to cause any interference in nearby electronic equipment.
RF emissions CISPR 11	Class B	The Ultra X is suitable for use in all establishments, including domestic establishments and those directly connected to the public low-voltage power supply network that supplies buildings used for domestic purposes.
Harmonic emissions IEC61000-3-2	Class A	
Voltage fluctuations/flicker emissions IEC 61000-3-3	Complies	

Guidance and manufacturer's declaration – electromagnetic immunity			
The Ultra X is intended for use in the electromagnetic environment specified below. The customer or the user of the Ultra X should assure that it is used in such an environment.			
Immunity test	IEC 60601 test level	Compliance level	Electromagnetic environment - guidance
Electrostatic discharge (ESD) IEC 61000-4-2	+/- 8 kV contact +/- 2 kV, +/- 4 kV, +/- 8 kV, +/- 15 kV air	+/- 8 kV contact +/- 2 kV, +/- 4 kV, +/- 8 kV, +/- 15 kV air	Floors should be wood, concrete or ceramic tile. If floors are covered with synthetic material, the relative humidity should be at least 30 %.
Electrical fast transients/bursts IEC 61000-4-4	±2kV 100kHz repetition frequency	±2kV 100kHz repetition frequency	Mains power quality should be that of a typical commercial or hospital environment.

Surge IEC 61000-4-5	Line to line: ±0.5kV, ±1kV Line to earth: ±0.5kV, ±1kV, ±2kV	Line to line: ±0.5kV, ±1kV Line to earth: ±0.5kV, ±1kV, ±2kV	Mains power quality should be that of a typical commercial or hospital environment.
Voltage dips, short interruptions and voltage variations on power supply lines IEC 61000-4-11	0% UT; 0.5 cycle at 0°, 45°, 90°, 135°, 180°, 225°, 270°, and 315° 0% UT; 1 cycle and 70% UT; 25/30 cycles sine phase at 0° 0% UT; 250/300 cycle	0% UT; 0.5 cycle at 0°, 45°, 90°, 135°, 180°, 225°, 270°, and 315° 0% UT; 1 cycle and 70% UT; 25/30 cycles sine phase at 0° 0% UT; 250/300 cycle	Mains power quality should be that of a typical commercial or hospital environment. If the user of devices require continued operation during power mains interruptions, it is recommended that devices be powered from an uninterruptible power supply or a battery
Power frequency magnetic field IEC 61000-4-8	30 A/m 50Hz or 60Hz	30 A/m 50Hz or 60Hz	Power frequency magnetic field should be at levels characteristic of a typical location in a typical commercial or hospital environment.
Note: UT: rated voltage(s); E.g. 25/30 cycles means 25 cycles at 50Hz or 30 cycles at 60Hz			

Guidance and manufacturer's declaration – electromagnetic immunity			
The Ultra X is intended for use in the electromagnetic environment specified below. The customer or the user of the Ultra X should assure that it is used in such an environment.			
Immunity test	IEC 60601 test level	Compliance level	Electromagnetic environment - guidance

Conducted disturbances induced by RF fields IEC 61000-4-6	3 V 0.15 MHz – 80 MHz, 6 V in ISM bands between 0.15 MHz and 80 MHz, 80 % AM at 1 kHz	3 V	Portable and mobile RF communications equipment should be used no closer to any part of the Ultra X , including cables, than the recommended separation distance calculated from the equation applicable to the frequency of the transmitter. Recommended minimum separation distances See the RF wireless communication equipment table in "Recommended minimum separation distances"
Radiated RF EM fields IEC 61000-4-3	3 V/m, 80 MHz – 2,7 GHz, 80 % AM at 1 kHz	3V/m	
Proximity fields from RF wireless communication equipment IEC 61000-4-3	See the RF wireless communication equipment table in "Recommended minimum separation distances"	Complies	

Recommended minimum separation distances						
<p>Nowadays, many RF wireless equipments have being used in various healthcare locations where medical equipment and/or systems are used. When they are used in close proximity to medical equipment and/or systems, the medical equipment and/or systems' basic safety and essential performance may be affected. The Ultra X has been tested with the immunity test level in the below table and meet the related requirements of IEC 60601-1-2:2014. The customer and/or user should help keep a minimum distance between RF wireless communications equipments and the Ultra X as recommended below.</p>						
Test frequency (MHz)	Band (MHz)	Service	Modulation	Maximum power (W)	Distance (m)	Immunity test level (V/m)
385	380-390	TETRA 400	Pulse modulation	1.8	0.3	27

			18Hz			
450	430-470	GMRS 460 FRS 460	FM ± 5 kHz deviation 1 kHz sine	2	0.3	28
710	704-787	LTE Band 13, 17	Pulse modulation 217Hz	0.2	0.3	9
745						
780						
810	800-960	GSM 800/900, TETRA 800, iDEN 820, CDMA 850, LTE Band 5	Pulse modulation 18Hz	2	0.3	28
870						
930						
1720	1700-1990	GSM 1800; CDMA 1900; GSM 1900; DECT; LTE Band 1, 3, 4, 25; UMTS	Pulse modulation 217Hz	2	0.3	28
1845						
1970						
2450	2400-2570	Bluetooth, WLAN, 802.11 b/g/n, RFID 2450, LTE Band 7	Pulse modulation 217Hz	2	0.3	28
5240	5100-5800	WLAN 802.11 a/n	Pulse modulation 217Hz	0.2	0.3	9
5500						
5785						



WARNING

1. Use of accessories and cables other than those specified or provided by the manufacturer of **Ultra X** could result in increased electromagnetic emissions or decreased electromagnetic immunity of **Ultra X** and result in improper operation.

Cable information:

Cable Name	Cable Length (m)	Shielded or not	Remark
Adapter Cable	1.2	No	/

2. Use of **Ultra X** adjacent to or stacked with other equipment should be avoided because it could result in improper operation. If such use is necessary, **Ultra X** and the other equipment should be observed to verify that they are operating normally.

12.Statement

Service Life

The service life of Ultra X handpiece is 3 years.

Disposal

The package should be recycled. Metal parts of the device are disposed as scrap metal. Synthetic materials, electrical components, and printed circuit boards are disposed as electrical scrap. The lithium batteries are disposed as special refuse. Please deal with them according to the local environmental protection laws and regulation.

Rights

All rights of modifying the product are reserved to the manufacturer without further notice. The pictures are only for reference. The final interpretation rights belong to CHANGZHOU SIFARY MEDICAL TECHNOLOGY CO., LTD. The industrial design, inner structure, etc, have claimed for several patents by SIFARY, any copy or fake product must take legal responsibilities.



Changzhou Sifary Medcial Technology Co., Ltd

Add: NO.99, Qingyang Road, Xuejia County, Xinbei District, Changzhou City,
213000 Jiangsu, China

Tel: +86-0519-85962691

Fax: +86-0519-85962691

Email: ivy@sifary.com

Web: www.eighteeth.com



Llins Service & Consulting GmbH

Tel: +49 175 4870819

Add: Obere Seegasse 34/2, 69124, Heidelberg, Germany

Email: Llins.Service@gmail.com

Version: 02

IFU-6235001

Issued: Nov. 11, 2019

All rights reserved.